



2.1 Channel Sound Bar with Wireless Subwoofer

FS2010



User Manual

Contents

| | | |
|---|-------------------------------------------------------------------------|----|
| 1 | Before you begin | 1 |
| | Important safety instructions..... | 2 |
| | Disposal of your old product and battery | 5 |
| 2 | Welcome | 6 |
| | What's in the box | 2 |
| | Overview of the Sound Bar | 7 |
| | Overview of the Remote Control | 8 |
| | Install/replace the remote control batteries | 9 |
| 3 | Set up your Sound Bar system | 11 |
| | Position Your Sound Bar and Subwoofer..... | 11 |
| | Mount your Sound Bar on the wall..... | 12 |
| 4 | Connect your Sound Bar system | 15 |
| | Connect with the AC power adapters..... | 15 |
| | Connect with the optical cable..... | 17 |
| | Direction for setting up your Sound Bar using an optical cable | 18 |
| | Connect with USB disk..... | 18 |
| 5 | Use your Sound Bar system | 19 |
| | Operation instruction | 19 |
| | Volume and Sound effect regulation | 21 |
| 6 | Specification | 22 |
| 7 | Trademarks | 24 |
| 8 | FAQ | 25 |



1 Before you begin

- Carefully read and observe all safety instructions in the safety leaflet.
- This sound bar is intended for indoor use only. In case it accidentally gets in contact with small amounts of water, unplug immediately and use a dry cloth to remove the water.
- Unplug the sound bar if it is not used for long periods of time or during lightning storms.
- Make sure the sound bar is installed on a solid surface or solidly wall-mounted below your TV for the best experience.
- Only use AAA 1.5V non-rechargeable batteries for the remote control.
- In case any of the cables are visibly damaged or pinched, unplug the sound bar and replace the cable.
- Be careful not to sharply bend the HDMI and optical cable as they may affect the performance.
- Protect your hearing by adjusting to a proper volume. Predefined and customizable sound settings are available for your listening comfort.

Important safety instructions

Make sure you read all the safety information before you use this product.

TCL Overseas Marketing Limited bears no responsibility for accidents or damages caused by unauthorized changes, modifications or improper use of the product.

| | | |
|-----------------------------------------------------------------------------------------------------------------------------------------------------------------|------------------------------------------------------------------------|-----------------------------------------------------------------------------------|
|  | CAUTION RISK OF ELECTRIC SHOCK DO NOT OPEN! |  |
| CAUTION: TO REDUCE THE RISK OF ELECTRIC SHOCK, DO NOT REMOVE COVER (OR BACK). NO USER SERVICEABLE PARTS INSIDE. REFER SERVICING TO QUALIFIED SERVICE PERSONNEL. | | |

| | |
|----------------------------------------------------------------------------------|---------------------------------------------------------------------------------------------------------------------------------------------------------------------------------------------------------------------------------------------------------------------|
|  | The lightning flash with arrowhead symbol, within an equilateral triangle is intended to alert the user to the presence of uninsulated dangerous voltage within the product's enclosure that may be of sufficient magnitude to constitute a risk of electric shock. |
|----------------------------------------------------------------------------------|---------------------------------------------------------------------------------------------------------------------------------------------------------------------------------------------------------------------------------------------------------------------|

| | |
|------------------------------------------------------------------------------------|----------------------------------------------------------------------------------------------------------------------------------------------------------------------------------------------------------------|
|  | The exclamation point within an equilateral triangle is intended to alert the user to the presence of important operating and maintenance (servicing) instructions in the literature accompanying the product. |
|------------------------------------------------------------------------------------|----------------------------------------------------------------------------------------------------------------------------------------------------------------------------------------------------------------|

| | |
|------------------------------------------------------------------------------------|----------------------------------------------------------------------------------------------------------------------------------------------------------------------------------------|
|  | This symbol indicates that this product incorporates double insulation between hazardous main voltage and user accessible parts. When servicing, use only identical replacement parts. |
|------------------------------------------------------------------------------------|----------------------------------------------------------------------------------------------------------------------------------------------------------------------------------------|

Warnings

- To reduce the risk of fire or electric shock, do not expose this product to rain or moisture. This product should not be exposed to dripping or splashing. No objects filled with liquids, such as vases, should be placed on or near the product.
- The product is unstable if it is not properly placed or mounted to the wall. Be sure to follow the wall mounting instructions provided in this user manual or Quick start guide to ensure your safety.
- Do not expose batteries to excessive heat such as sunshine, fire, and so forth.

Safety

- **Read these instructions** - Read all the safety and operating instructions before operating the product.
- **Retain these instructions** - Retain the safety and operating instructions for future reference.
- **Heed all warnings** - Adhere to all warnings on the product and in the operating instructions.
- **Follow all instructions** - Follow all operating and use instructions.
- **Do not use this apparatus near water** – The appliance should not be used near water or moisture – for example, in a wet basement or near a swimming pool and the like.
- **Clean only with a dry cloth.**
- **Do not block any ventilation openings.** Install in accordance with the manufacturer's instructions.
- **Do not install near any heat sources** such as radiators, heat registers, stoves, or other apparatus (including amplifiers) that produce heat.
- **Do not defeat the safety purpose** of the polarized or grounding-type plug. A polarized plug has two blades with one wider than the other. A grounding type plug has two blades and a third grounding prong. The wide blade or the third prong are provided for your safety. If the provided plug does not fit into your outlet, consult an electrician for replacement of the obsolete outlet.
- **Protect the power cord** from being walked on or pinched particularly at plugs, convenience receptacles, and the point where it exits from the product.
- **Use only attachments/accessories** specified by the manufacturer.



- **Use only with the cart**, stand, tripod, bracket, or table specified by the manufacturer, or sold with the apparatus. When a cart is used, use caution when moving the cart/apparatus combination to avoid injury from tip-over.
- **Unplug this apparatus** during lightning storms or when unused for long periods of time.
- **Refer all servicing** to qualified service personnel. Servicing is required when the apparatus has been damaged in any way, such as power-supply cord or plug damaged, liquid has been spilled or objects have fallen into the apparatus, the apparatus has been exposed to rain or moisture, does not operate normally, or has been dropped.
- **This appliance is** not intended for use by young children or infirm persons without supervision. Young children should be supervised to ensure that they do not play with the appliance.

Cautions

- Do not place any sources of danger on the product (for example, liquid filled objects, lighted candles).
- Disconnect the power cord to shut off when find trouble or not in use. The power cord shall be readily operable.
- Use of controls or adjustments or performance of procedures other than those described herein, may result in hazardous radiation exposure or other unsafe operation.
- The power cord/appliance coupler is used as the disconnect device, the disconnect device must remain readily operable.
- The rating label is located at the bottom or back of the product.
- The use of apparatus in tropical and moderate climates.

Battery precautions

- Do not mix batteries (old and new or carbon and alkaline).
- Do not dispose of batteries in fire or water.
- Recycle or dispose of batteries as per state and local guidelines.
- Danger of explosion if battery is incorrectly replaced. Replace only with the same or equivalent type.
- When the remote control is not to be used for a long time (more than a month), remove the battery from the remote control to prevent it from leaking.

- If the batteries leak, wipe away the leakage inside the battery compartment and replace the batteries with new ones.
- Keep away the batteries from heat or moisture.
- Do not carry or store batteries with other metallic objects. Doing so could cause batteries to short circuit, leak or explode.
- Never recharge a battery unless it is confirmed to be a rechargeable type.

Disposal of your old product and battery

Your product is designed and manufactured with high quality materials and components, which can be recycled and reused. This product may contain lead and mercury. Disposal of these materials may be regulated due to environmental considerations. For disposal or recycling information, please contact your local authorities. This product contains batteries:

- Do not incinerate. Batteries may explode if overheated.
- For disposal or recycling information, please contact your local authorities.

CAUTION: Risk of explosion if the battery is replaced by an incorrect type.

CAUTION: replacement of a battery with an incorrect type that can defeat a safeguard.

CAUTION: disposal of a battery into fire or a hot oven, or mechanically crushing or cutting of a battery, that can result in an explosion;

CAUTION: leaving a battery in an extremely high temperature surrounding environment that can result in an explosion or the leakage of flammable liquid or gas.

CAUTION: a battery subjected to extremely low air pressure that may result in an explosion or the leakage of flammable liquid or gas.

2 Welcome

Congratulations on the purchase of your new FFALCON Sound Bar! After it is set up and connected, you can experience a super sound quality and state-of-the-art design to best fit your home entertainment system. You are recommended to read through this user manual which helps you set up, connect and operate the product easily and properly.

Let's get started.

What's in the box



Sound Bar main unit



Subwoofer



AC adapter x 2



RCA-3.5mm cable



Remote control

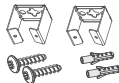

Wall anchor x 2
Wall mount bracket x 2
Wall bracket screw x 2



Warranty Card



User Manual



Wall Mount Template

Overview of the Sound Bar

Button and jack definition:

Buttons and jacks are defined as follows:

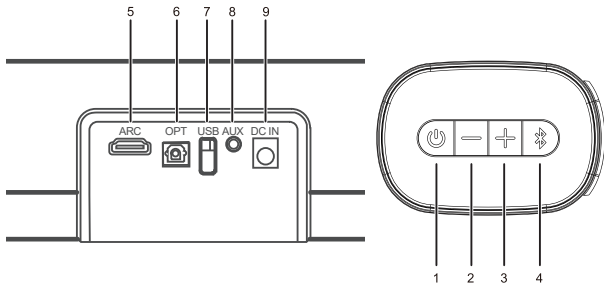

1. : Press to power on, short press to switch function, long press to power off
2. : Press for volume down
3. : Press for volume up
4. : Press for Bluetooth pairing
5. ARC: HDMI ARC
6. OPT: Optical input
7. USB: USB input
8. AUX: 3.5mm connector
9. DC IN: DC14V 2A input

Function indicator light:

1. Red light: in standby mode
2. White light: in operation

Overview of the Remote Control

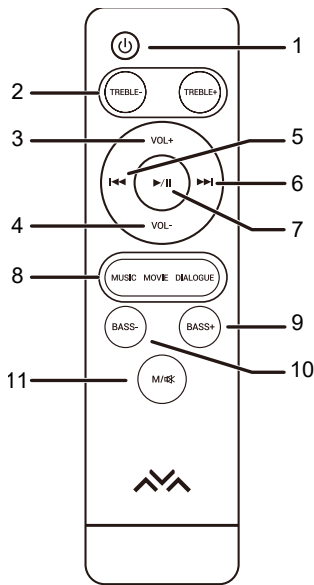

1. : Press to power on and power off.
2. TREBLE +: Press to increase treble
TREBLE -: Press to decrease treble.
3. VOL +: Press to increase volume.
4. VOL -: Press to decrease volume.
5. : Press to play previous song under Bluetooth and USB mode.
6. : Press to play next song under Bluetooth or USB.

7. **▶/||**: Press to play or pause playing under Bluetooth or USB.
8. **MUSIC**: Press to enter the MUSIC sound mode.
MOVIE: Press to enter the MOVIE sound mode.
DIALOGUE: Press to enter the DIALOGUE sound mode.
9. **BASS +**: Press to increase bass.
10. **BASS -**: Press to decrease bass.
11. **M/🔇**: Press to change mode; press and hold to mute sound.

Install/replace the remote control batteries

Warnings

Danger of explosion if battery is incorrectly replaced.

Replace only with the same or equivalent type.

Batteries either installed or packed must not be to heat like direct sunlight, fire or similar.

Install the Remote Control:

1. Open the battery compartment, remove the old batteries if necessary.
2. Place two new AAA batteries into the battery compartment with the correct polarity (+/-).
3. Close the battery compartment.

1

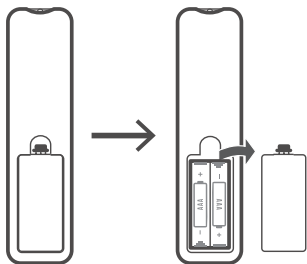

2

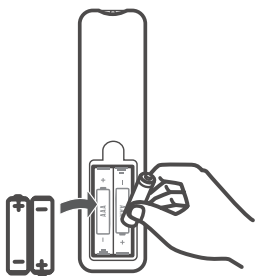

3

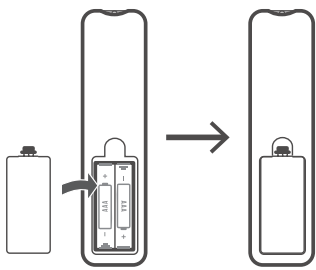

3 Set up your Sound Bar system

Make sure you read all the safety information before you mount the Sound Bar main unit on the wall.

Make sure you use screws provided or specified by the authorized manufacturer.

FFALCON bears no responsibility for accidents or damage caused by improper wall mounting and screws installation or insufficient wall strength, etc.

Additional tools (not supplied) are required for installation.

Position Your Sound Bar and Subwoofer

The ideal place to position the Sound Bar main unit is centered underneath your TV.

You are recommended to place the Sound Bar main unit on the top of the cabinet and right below the center of your TV. The distance between the subwoofer and the Sound Bar main unit should be less than 3m.

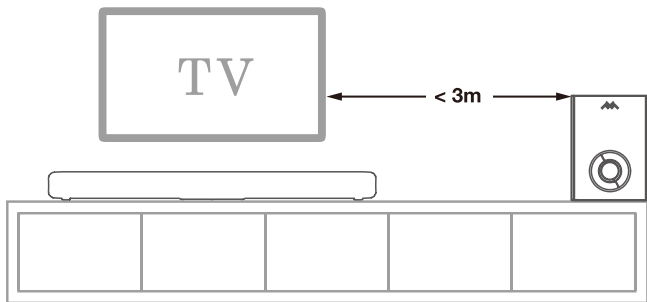

Mount your Sound Bar on the wall

You can choose to mount your Sound Bar main unit on the wall.

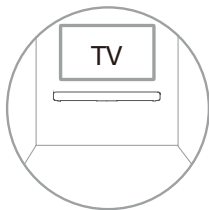

1. Place the supplied wall mount template on the wall. Make sure the wall mount template is at least 10cm below the center of the TV.
2. Use a level to make sure the Sound Bar is positioned accurately.
3. Use the tape to stick the wall mount template firmly on the wall.

4. Mark on the wall using each marking on the template through the mounting holes.
5. Take away the wall mount template.
6. Drill a screw hole at each marking on the wall.

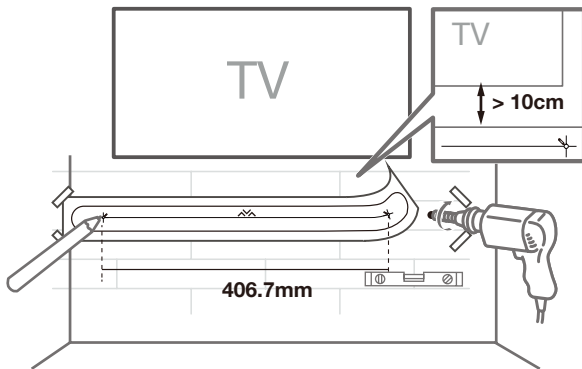

7. Take out the screws from the rear of the sound bar, 2 per side.
8. Use a screwdriver to attach the mounting brackets to the sound bar.
9. Installation complete.

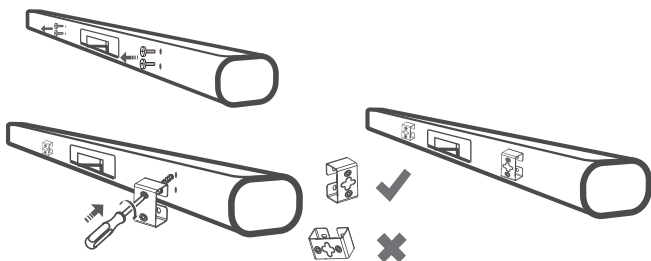

10. Insert the supplied wall anchors into 2 screw holes on the wall.
11. Insert the supplied screws into the wall anchors.
12. Fix and tighten the screws on the wall.
13. Hang the Sound Bar main unit on the screws.

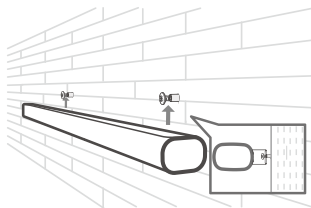
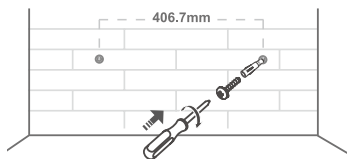

4 Connect your Sound Bar system

After you have fixed the position of the Sound Bar, you can start connecting it to your TV or other devices and listen to the audio through your Sound Bar. Make sure you have muted the audio of your TV or device. For information, check the user manual of your TV or device.

Connect with the AC power adapters

Connect the supplied AC power adapters to the sound bar main unit and subwoofer.

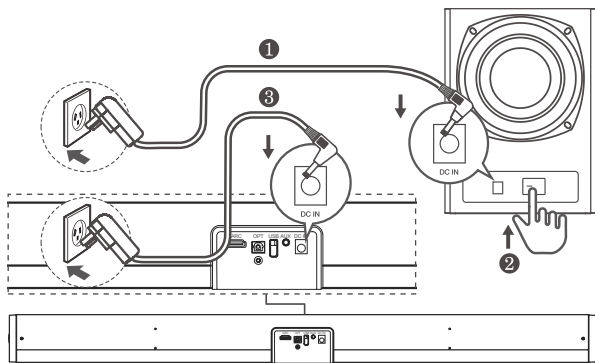

Connect with the HDMI cable

Note:

Make sure your TV or device supports the HDMI ARC feature. For information, check the user manual of your TV or device.

Connect one end of the HDMI cable to the HDMI ARC input connector on your Sound Bar and another end to the HDMI ARC output connector of your TV or device.

To get the best possible audio experience using the HDMI cable, follow below given steps:

For FFALCON TV:

- Connect HDMI cable from the HDMI (ARC) interface on the sound bar to the HDMI (ARC/eARC) interface on the TV. Connect power cord.
- Enable the CEC function in the settings of the FFALCON TV.

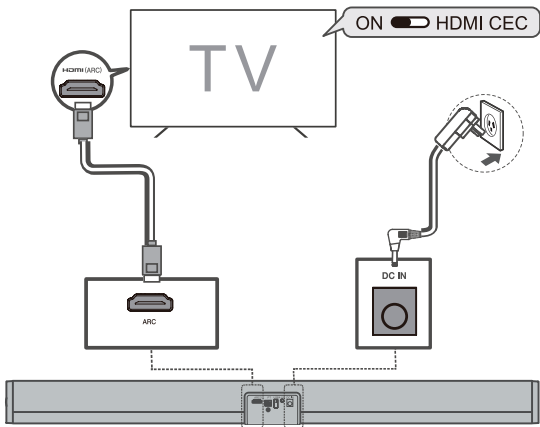

Connect with the optical cable

1. Remove the protective caps from the optical cable when necessary.
2. Connect one end of the optical cable to the optical input connector on your Sound Bar and another end to the optical output connector of your TV or device.

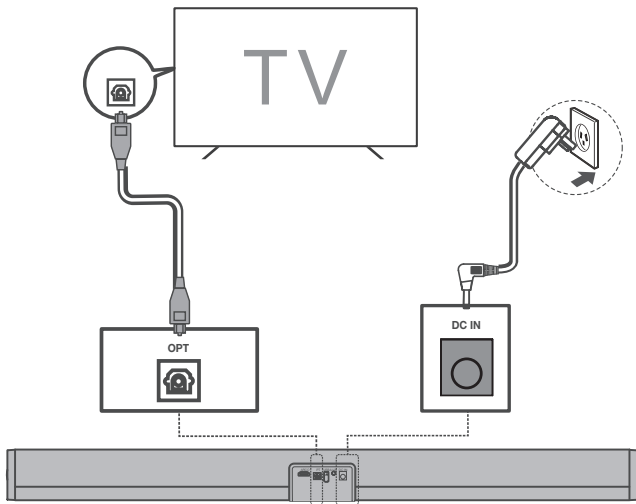

Note

- If there is no sound output from the Sound Bar, try to activate the PCM signal output on your TV or device. For more information of how to activate the PCM signal output,

check the user manual of your TV or device.

Direction for setting up your Sound Bar using an optical cable



Do not bend or kink the optical cable (SPDIF) as it is fragile and can easily get damaged and broken.

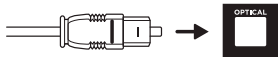

To get the best possible audio experience using the optical cable:

- 1 Press the Home button on your FFALCON TV Remote.
- 2 Navigate to **Audio option** under **Settings**.
- 3 Uncheck the “**TV speaker enabled**” option.
- 4 Under **S/PDIF** and **ARC**, select **PCM-Stereo**.

Notes

- *Different devices may have different menu options.*
- *Devices such as Blu-ray players, set-top boxes, etc. are also applicable.*

Connect with USB disk

- Press ►/|| on the remote control to listen to/pause/ resume the music.

- Press **⏮** or **⏭** on the remote control to skip to the previous or next track.
- Press **VOL+** or **VOL-** to increase or decrease the volume level.

5 Use your Sound Bar system

Get Started:

1. Make sure you have made all the necessary cable connections before connecting the Sound bar to a wall outlet, the sound bar will enter to standby mode, the indicator will light up in red.
2. Make sure the subwoofer is connected to the power, and turn the button to "ON"
3. Press "**⏻**" on unit or remote control to turn on the sound bar. The Bluetooth indicator will light up.
4. Press "**⏻**" on unit or on remote control to choose various source.

Operation instruction

● Bluetooth Mode

After power on, the machine directly enters Bluetooth mode, along with voice prompt and white light slow flash; Bluetooth enters the pairing status, with voice prompts.

1. Put the phone within 3m in distance;

2. Activate the Bluetooth function of the phone, so that the phone starts to search for the Bluetooth device (please refer to the phone instructions for details);
3. Select "FS2010" from the device that has been searched for, click connection, with voice prompt;
4. If the phone remind you to enter password, enter "0000" and press confirm button to match sound bar to the phone;
5. Press the back button of the phone to exit the phone menu. Make sure the distance between sound bar and phone is within 10m and there is no obstacles. At this time, music can be played on the sound bar;
6. Short press "▶/⏸" to play and pause music. Short press "◀◀" or "▶▶" button to previous or next song;
7. To disconnect, short press or long press the "📶" button on the sound bar, At this time, another mobile phone device can be used to connect Bluetooth playing; If the connection is not selected, the machine will be on waiting for connection status.

● **AUX Mode**

After power on, connect the external audio sources to the AUX jack of sound bar by using the 3.5mm audio cable, and then Press the "🔊" button on the sound bar or the "AUX" button on the remote control to switch to "AUX" mode. At this time, music from the external audio sources such as MP3/CD can be played. (please adjust the volume of the external audio sources accordingly at a comfortable level.)

● **HDMI Mode**

Press the "⏻" button on the sound bar or "HDMI" button on the remote control to switch to "HDMI" mode. At this point, connect the HDMI cable to the TV set and then to the HDMI IN(ARC) jack on the back of the sound bar. The soundbar will detect the digital signal transmitted by the TV to decode and restore audio playback. (You can now control the TV volume with the soundbar remote, and vice versa. HDMI ARC support is needed on the TV).

● **OPTICAL Mode**

Press the "⏻" button on the sound bar or "OPTICAL" button on the remote control to switch to "OPTICAL" mode. At this time, connect the DVD audio and equipment to Sound bar's OPT IN jack with the optical cable. This machine decodes optical fiber digital to restore sound through power amplifier.

● **USB Mode**

After power on, insert the USB into the USB jack of the sound bar; the sound bar automatically goes to USB playback mode and plays the music in USB. Press the "▶/⏸" button to play and pause the music. Press "◀◀" or "▶▶" button to select music up and down.

Volume and Sound effect regulation

A. After power on, in any mode of playback, Press or long press the volume button "VOL-" on the sound bar or remote control to lower the volume. Press or long press the volume button "VOL+" on the sound bar or remote control to raise the volume.

Note: during volume increase and decrease, the indicator light flash; when the volume is increased to the maximum or decreased to the minimum, the indicator light will be on.

- B. After power on, in any mode of playback, Press the remote control to choose sound effect mode: MUSIC, MOVIE and DIALOGUE.

Note:

1. Under MOVIE mode, there is no function when press "BASS(+, -)", "TREBLE(+, -)"; Under MUSIC and DIALOGUE mode, It can adjust sound effect between positive and negative six grades when press "BASS (+, -)", "TREBLE (+, -)" on the remote control.

2. The user can adjust each kind of sound effect mode to enjoy the music according to the personal preference!

6 Specification

| | |
|---------------------------|------------------------------------------------------------------------------------------------------------------------------------------------|
| Product name | FS2010 |
| Output power | 20W*2 + 30W |
| AC/DC adapter | Input: 100-240V-50/60Hz 1.2A MAX Output: 14V  2A |
| Speaker frequency | 50Hz-20KHz |
| Bluetooth version | 5.1 |
| Bluetooth range | Up to 10m |
| Included in the packaging | Sound bar, Subwoofer, Remote control, AC adapters, AUX cable (3.5mm to RCA), User Manual, Wall-mounted bracket and screws, Wall mount template |
| Dimensions/Weight | Soundbar: 810 x 70 x 99 mm/1.34 kg Subwoofer: 165 x 240 x 298 mm/2.02 kg |
| Remote Control | Distance/Angel: 6m/30° Battery type: AAA battery X 2 |

7 Trademarks

Bluetooth



The Bluetooth® word mark and logos are registered trademarks owned by Bluetooth SIG, Inc. and any use of such marks by TCL Electronics Australia Pty Ltd. under license. Other trademarks and trade names are those of their respective owners.

HDMI



HDMI, and HDMI logo and High-Definition Multimedia Interface are trademarks or registered trademarks of HDMI licensing LLC.

8 FAQ

Bluetooth paired, connection cannot be completed

Another mobile device may be connected to the sound bar. Disconnect the other connected bluetooth device. Once the device is disconnected, you device should pair automatically-provided it was previously paired.

Volume of Bluetooth playback is low

1. After connections with mobile devices, the volume of Bluetooth device is not up-but at the default output level. Turn up the mobile device volume.
2. Output volume of Bluetooth device is low itself.

Short Bluetooth connection distance

Obstruction exists between mobile devices and Bluetooth device. Remove obstructions.

Bluetooth connection plays normally, sometimes with broken sound.

1. Obstruction exists between mobile devices and Bluetooth device. Remove obstructions.
2. Too far away from Bluetooth device to connected mobile devices, beyond the connection range. Shorten the distance between the Bluetooth device and mobile devices.

Subwoofer not working

Turn on the sound bar and enter Bluetooth mode,double press quickly the pair button, then turn on the subwoofer, the red LED light on subwoofer will be off.

Plays no sound

Make sure you activate the PCM signal output on your TV or device when the HDMI ARC/Optical audio source is selected on the sound bar. For more information of how to activate the PCM signal output, check the user manual of your TV or device.

Note: If you go through the above steps and still have issues, please notify the technician or the customer service!

WARNING:

BATTERIES EITHER INSTALLED OR PACKED MUST NOT BE TO HEAT LIKE DIRECT SUNLIGHT, FIRE OR SIMILAR.

www.ffalcon.com/au

Customer Support: 1300 170 540

**WE ARE
READY TO
HELP** contact us first
with any questions



**TAKE CARE WHEN
REMOVING THE SOUND BAR**

2022 © TCL Electronics Australia Pty Ltd. All rights reserved.

This product has been manufactured by and is sold under the responsibility of TCL Electronics Australia Pty Ltd.

FS2010-AU_UM_FFALCON_V1.2